

# SHARP®

MODEL: MX-C400P

DIGITAL FULL COLOR PRINTER

# Quick Start Guide

## Before using the machine

Functions of the machine and procedures for loading paper.

## Printing

Basic procedures for using the machine.

## System settings

Configuring settings to make the machine easier to use.

## Troubleshooting

Frequently asked questions and how to clear paper misfeeds.





Keep this manual close at hand for reference whenever needed.

# OPERATION MANUALS AND HOW TO USE THEM

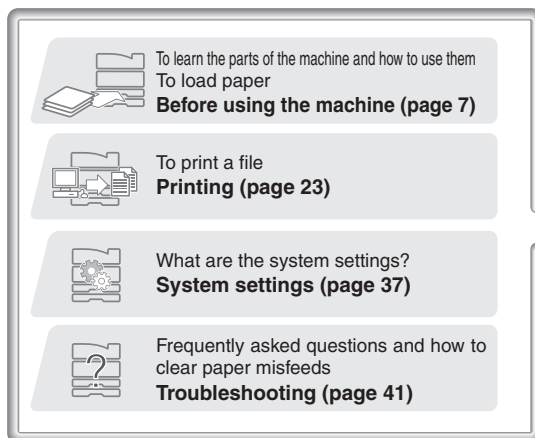
Three printed manuals and a manual in PDF format are provided with the machine.

## Printed manuals



-  To learn the parts of the machine and how to use them  
To load paper  
**Before using the machine (page 7)**
-  To print a file  
**Printing (page 23)**
-  What are the system settings?  
**System settings (page 37)**
-  Frequently asked questions and how to clear paper misfeeds  
**Troubleshooting (page 41)**

## Quick Start Guide

(this manual)

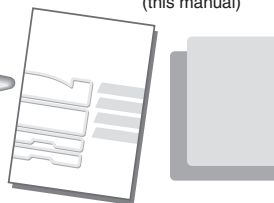

This manual provides easy-to-understand explanations of the functions of the machine in a single manual.

The explanations in this manual focus on frequently used functions. For special functions, troubleshooting, and detailed procedures for using the machine, see the manual in PDF format.



Please read before using the machine.

## Safety Guide

Contains important cautionary information and machine specifications.



## Software Setup Guide

Explains the procedures for installing the printer driver.



## Color Chart

This chart is used for comparison when color balance is adjusted on the machine.

# Manuals in PDF format

Detailed explanations of the functions that can be used on the machine are provided in the Operation Guide in PDF format. The Operation Guide can be downloaded from the Web pages in the machine.

## Operation Guide

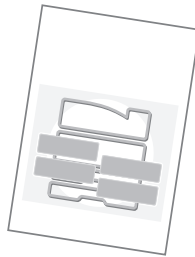

Download the Operation Guide from the Web pages in the machine.

Name	Desc
⊕ Operation Guide	Oper

Download(O)



For the downloading procedure, see "Downloading the Operation Guide" (page 4).

\* To view the Operation Guide in PDF format, Adobe® Reader® or Acrobat® Reader® of Adobe Systems Incorporated is required. Adobe® Reader® can be downloaded from the following URL:  
<http://www.adobe.com/>

# CHECKING THE IP ADDRESS

To check the IP address of the machine, print out the all custom setting list in the system settings.

SYSTEM SETTINGS 

**1** Press the [SYSTEM SETTINGS] key.

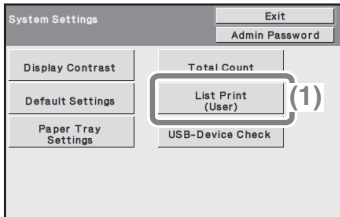

**2** Select the all custom setting list.

(1) Select the [List Print (User)] key.

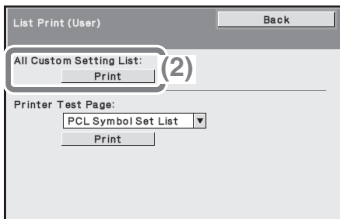

(2) Select the [Print] key to the right of "All Custom Setting List".

The IP address is shown in the list that is printed.



# ACCESSING THE WEB SERVER IN THE MACHINE

When the machine is connected to a network, the machine's built-in Web server can be accessed from a Web browser on your computer.

## Opening the Web pages

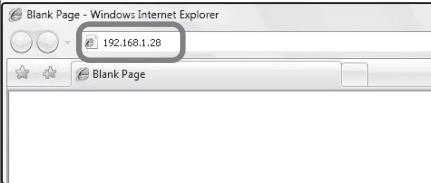

**Access the Web server in the machine to open the Web pages.**

**Start a Web browser on a computer that is connected to the same network as the machine and enter the IP address of the machine.**

Recommended Web browsers

- Internet Explorer: 6.0 or higher (Windows®)
- Netscape Navigator: 9 (Windows®)
- Firefox: 2.0 or higher (Windows®)
- Safari: 1.5 or higher (Macintosh)

The Web page will appear.

The machine settings may require that user authentication be performed in order to open the Web page. Please ask the administrator of the machine for the password that is required for user authentication.

# Downloading the Operation Guide

The Operation Guide, which is a more detailed manual, can be downloaded from the machine's Web pages.

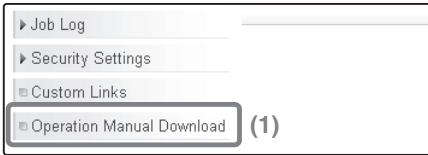

## Downloading the Operation Guide.

(1) Click [Operation Manual Download] in the menu of the Web page.



(2) Select the desired language.

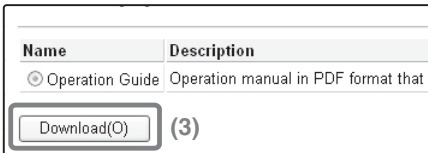

(3) Click the [Download] button.

The Operation Guide is downloaded.

# TABLE OF CONTENTS

CHECKING THE IP ADDRESS . . . . .	2
ACCESSING THE WEB SERVER IN THE MACHINE . . . . .	3

## Before using the machine

PART NAMES AND FUNCTIONS . . . . .	8
SUPPLIES . . . . .	9
OPERATION PANEL . . . . .	10
USING THE OPERATION PANEL . . . . .	12
ITEMS IN THE DISPLAY . . . . .	14
USER AUTHENTICATION . . . . .	16
CHANGING PAPER IN A TRAY . . . . .	18

## Printing

PRINTING . . . . .	24
CANCELING PRINTING (AT THE MACHINE) . . . . .	30
SELECTING PRINT SETTINGS . . . . .	32
CONVENIENT PRINTER FUNCTIONS . . . . .	34

## System settings

SYSTEM SETTINGS . . . . .	38
---------------------------	----

## Troubleshooting

FREQUENTLY ASKED QUESTIONS . . . . .	42
REMOVING MISFEEDS . . . . .	46





# Before using the machine

This section provides general information about the machine, including the names and functions of the parts of the machine and its peripheral devices, and the procedures for loading paper.

▶ PART NAMES AND FUNCTIONS .....	8
▶ SUPPLIES .....	9
▶ OPERATION PANEL .....	10
▶ USING THE OPERATION PANEL .....	12
▶ ITEMS IN THE DISPLAY .....	14
▶ USER AUTHENTICATION .....	16
▶ CHANGING PAPER IN A TRAY .....	18

# PART NAMES AND FUNCTIONS

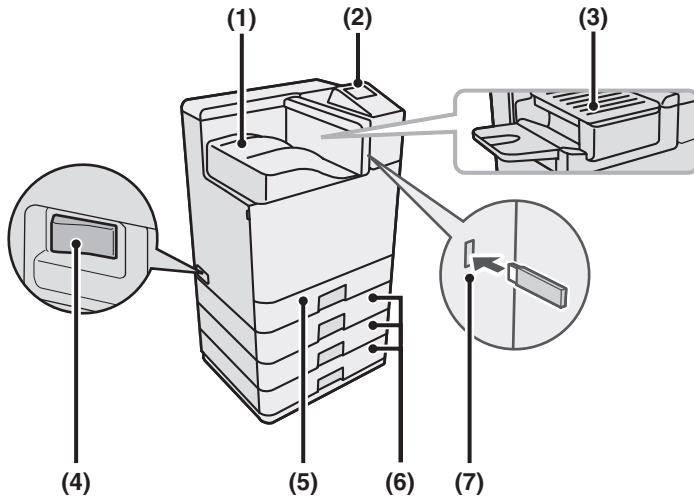

**(1) Output tray (center tray)**

Jobs are delivered to this tray.  
(When a finisher is installed, the output tray (center tray) cannot be used.)

**(2) Operation panel**

**(3) Finisher\***

This can be used to staple output.

**(4) Main power switch**

This is used to power on the machine.

**(5) Tray 1**

Up to 500 sheets of paper (21 lbs. (80 g/m<sup>2</sup>)) can be loaded in each tray.

**(6) Tray 2/Tray 3/Tray 4 (500-sheet paper feed unit is installed)\***

This holds paper. Up to 500 sheets (21 lbs. (80 g/m<sup>2</sup>)) of paper can be loaded.

**(7) USB connector (type A)**

Supports USB 2.0 (Hi-Speed).  
This is used to connect a USB memory or other USB device to the machine.

\*Peripheral device. For more information, see "PERIPHERAL DEVICES" in "Chapter 1 - BEFORE USING THE MACHINE" in the Operation Guide.

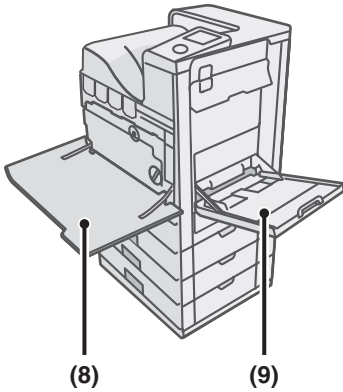

**(8) Front cover**

Open to replace a toner cartridge.

**(9) Bypass tray**

Special types of paper and envelopes can be fed from the bypass tray.

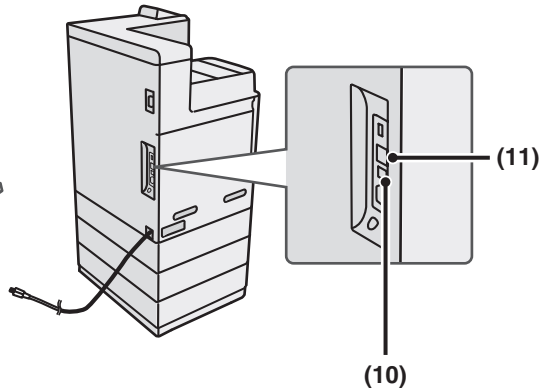

**(10) USB connector (B type)**

Supports USB 2.0 (Hi-Speed).

A computer can be connected to this connector to use the machine as a printer.

**(11) LAN connector**

Connect the LAN cable to this connector when the machine is used on a network.

# SUPPLIES

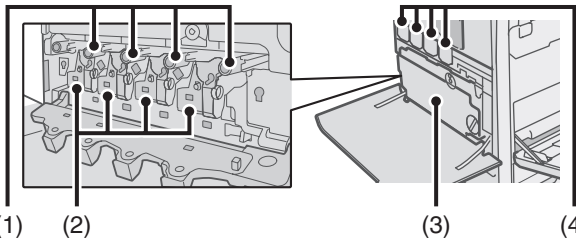

**(1) Drum cartridges**

This contains the photosensitive drum that is used to create images for printing.

**(2) Developer cartridges**

This contains the developer that is necessary to transfer the toner to the paper.

**(3) Toner collection container**

This collects excess toner that remains after printing.

**(4) Toner cartridges**

These contain toner for printing. When the toner runs out in a cartridge, the cartridge of the color that ran out must be replaced.

# OPERATION PANEL

## Display

Select the displayed items to perform various operations.

## [PRINT] key

When you wish to print a print hold job, press this key to switch to print mode. You can hold down the [PRINT] key to check the total pages used, remaining toner, and machine display.

## [SYSTEM SETTINGS] key

Press to display the system settings menu screen. You can configure paper tray and other settings to suit the needs of your workplace.

## Sharp OSA shortcut key

Press to display a shortcut to Sharp OSA (open systems architecture) mode (when the application communication module is installed).

## [JOB STATUS] key

Press this key to view the job status screen. You can check the status of jobs and cancel jobs in the job status screen.

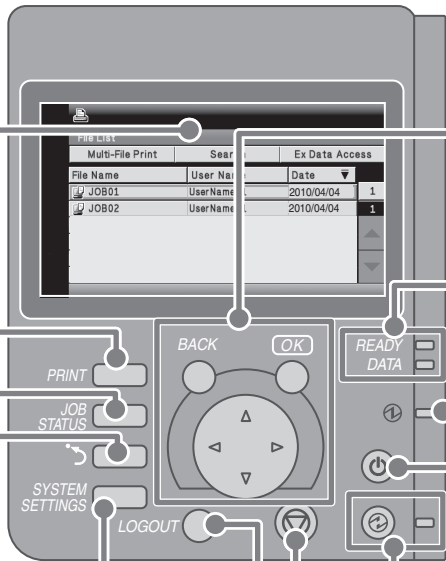

### [OK] key / [BACK] key / Arrow keys

#### [OK] key

Press to enter a setting that has been selected.

#### [BACK] key

Press to return to the previous screen level.

#### Arrow keys

Press to move the selection frame that selects setting keys and items in the display.

### Print mode indicators

#### READY indicator

Print data can be received when this indicator is lit.

#### DATA indicator

This blinks while print data is being received and lights steadily while printing is taking place.

### Main power indicator

This indicator lights when the main power is switched on.  
The main power switch is on the left side of the machine.

### [POWER] key

Use this key to turn the machine power on and off.

### [STOP] key

Press this key to stop a printing job.

### [LOGOUT] key

When user authentication is enabled, press this key to log out after using the machine.

### [POWER SAVE] key / indicator

Use this key to activate power save mode. The [POWER SAVE] key blinks when the machine is in power save mode. This key is also used to deactivate power save mode.

# USING THE OPERATION PANEL

This section explains the procedures for selecting setting items in the screen.

## Selecting setting items

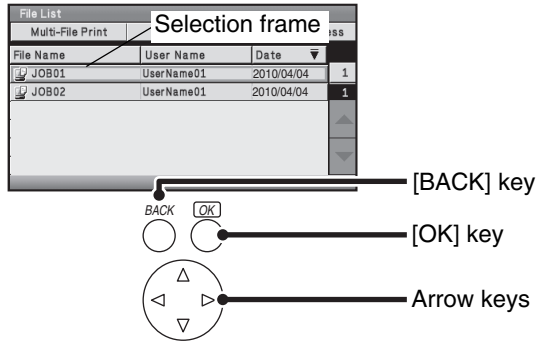

**Base screen**

The frame that appears in the display is the selection frame.

Move the selection frame to the item that you wish to select and press the [OK] key.

The selection frame is moved with the arrow keys (⏮ ⏭ ⏪ ⏩).

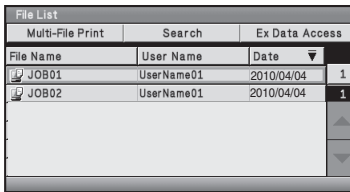

When the ⏩ key and the [OK] key is pressed...

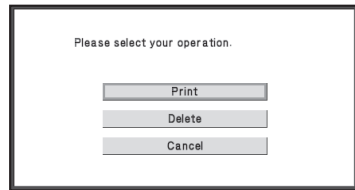

The operation selection screen appears.

Press the [BACK] key to return to the previous screen level.

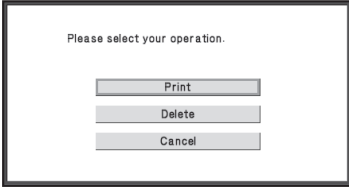

When the [BACK] key is pressed in the operation selection screen,



File List			
Multi-File Print	Search	Ex Data Access	
File Name	User Name	Date	
JOB01	UserName01	2010/04/04	1
JOB02	UserName01	2010/04/04	1

you return to the base screen.

# ITEMS IN THE DISPLAY

Useful items in the display are explained below.

Messages appear here.

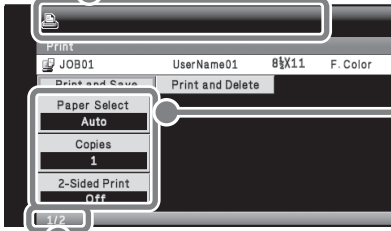

Settings appear here.  
If you press the  $\nabla$  key when the selection frame is on the bottom setting, the next screen will appear.

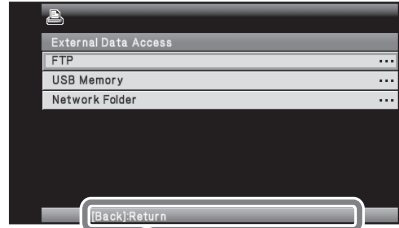

Numbers in the format "1/2" indicate that there are more items.  
These numbers mean "current screen / total number of screens".

An operation hint appears here.



## Important operations to know

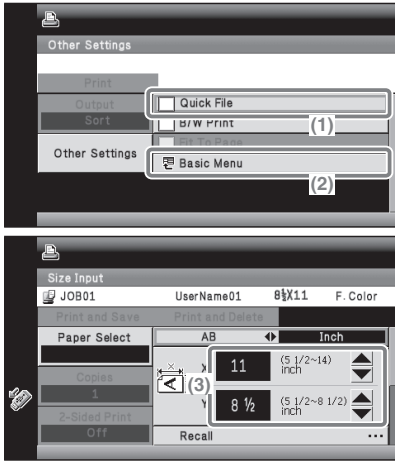

- (1) When a checkbox  is selected and the [OK] key is pressed, a checkmark  will appear to indicate that the setting is enabled.
- (2) You can select "Basic Menu" to return to that screen.
- (3)   can be used to increase or decrease a value. To make the value change quickly, hold down the [OK] key.

## Job status screen

To show the job status screen, press the [JOB STATUS] key on the operation panel. You can check the status of a printing job being executed in the job status screen.

JOB STATUS



To change the jobs that are displayed, change the status (spool, reserved/executing, complete).

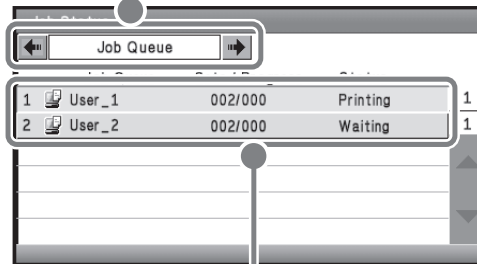

Jobs are displayed as a list. The jobs appear in the order that they will be run. A selected job can be given priority and run ahead of other jobs, or a job waiting in the queue can be canceled.

# USER AUTHENTICATION

When user authentication is enabled, you must log in before using the machine. User authentication is initially disabled.

When you have finished using the machine, log out.

## User authentication methods

There are two methods for performing user authentication: login by user number and login by login name and password. Ask the administrator of the machine for the information that is required to log in.

For details on user authentication, see "USER AUTHENTICATION" in "Chapter 1 - BEFORE USING THE MACHINE" in the Operation Guide.

### Login by user number

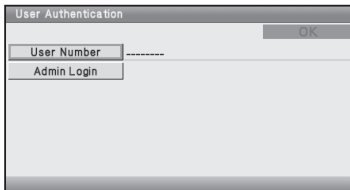

The screenshot shows a window titled "User Authentication" with an "OK" button in the top right corner. Below the title bar, there are two input fields: "User Number" followed by a dashed line indicating a numeric input, and "Admin Login".



This method requires that you log in by entering your previously stored user number (5 to 8 digits) with the soft numeric keypad.

### Login by login name and password

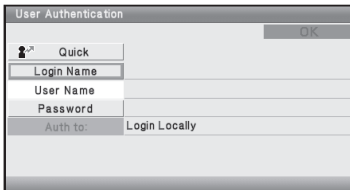

The screenshot shows a window titled "User Authentication" with an "OK" button in the top right corner. Below the title bar, there are several input fields: "Quick" with a user icon, "Login Name", "User Name", "Password", and "Auth to:" with "Login Locally" selected.



This method requires that you log in by entering your login name, password, and the login destination. Depending on the authentication settings, it may also be necessary to enter your e-mail address.

## Logging out

When you have finished using the machine, log out. Logging out prevents unauthorized use of the machine.

### How to log out

You can log out from any mode of the machine by pressing the [LOGOUT] key.

If a preset duration of time elapses after the machine is last used, the auto clear function will activate. When auto clear activates, logout automatically takes place.

# CHANGING PAPER IN A TRAY

## Names of the trays

The names of the trays are shown below.

For the number of sheets of paper that can be loaded in each tray, see the following manuals:

- Operation Guide, "Paper Tray Settings" in "Chapter 3 - SYSTEM SETTINGS"
- Safety Guide, "SPECIFICATIONS"

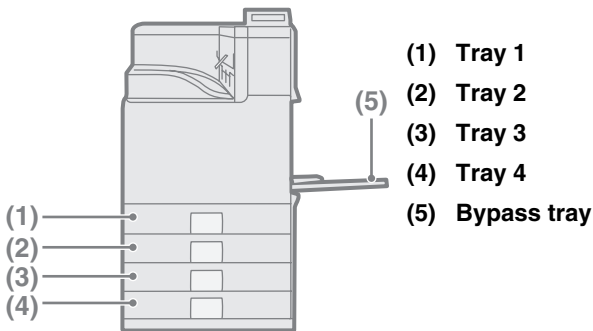

## Print side face up or face down

Paper is loaded with the print side face up or face down depending on the paper type and tray.

Tray	Print side*
Tray 1 to 4	Face up
Bypass tray	Face down

\* When loading "Pre-Punched", "Letter Head", or "Pre-Printed" paper in the paper tray, the direction the print side faces is different.

For more information, see "LOADING PAPER" in "Chapter 1 - BEFORE USING THE MACHINE" in the Operation Guide.

# Loading paper in a tray

To change the paper in a tray, load the desired paper in the tray and then change the tray settings in the machine to specify the loaded paper. The procedure for changing the tray paper size is explained below. As an example, the paper in tray 1 is changed from 8-1/2" x 11" (A4) size plain paper to 5-1/2" x 8-1/2" (A5) size recycled paper.

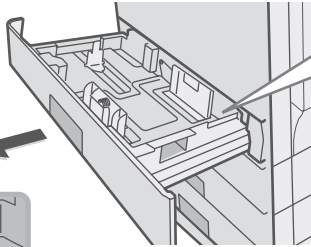

Gently pull out the paper tray. If paper remains in the tray, remove it.

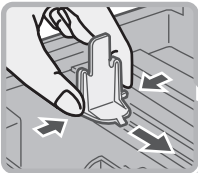

Move the two guides on the tray. For example, move the guides from 8-1/2" x 11" (A4) to 5-1/2" x 8-1/2" (A5). Adjust the guides to match the paper being loaded. If the guides are too loose, the paper will not be held in place. If the guides are too tight, the paper will bow.

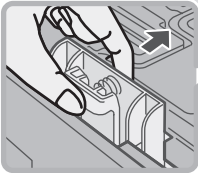

Load the paper so that it is not as shown below when viewed from the front and side of the machine.



The loaded paper should not go higher than these protrusions.

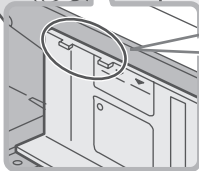

Insert the paper with the print side face up.

Fan the paper well before inserting it. Otherwise, multiple sheets may feed at once and cause a misfeed.

Insert the paper and then gently push the tray into the machine.

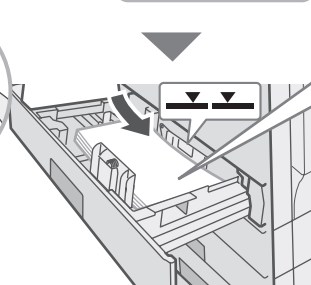

 Indicator line

The indicator line indicates the maximum height of the paper that can be loaded in the tray.

When loading paper, make sure that the stack is not higher than the indicator line.

# Changing the tray settings

When you change the paper in a tray, the tray settings in the system settings must also be changed.

SYSTEM SETTINGS 

**1** Press the [SYSTEM SETTINGS] key.

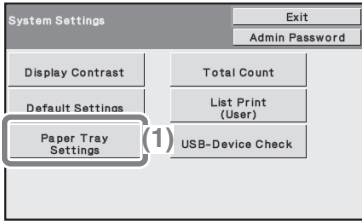



**2** Configure the tray settings.

**(1)** Select the [Paper Tray Settings] key.

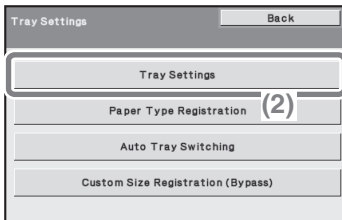
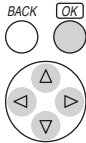
Select with     and press [OK].



**(2)** Select the [Tray Settings] key.

Select with   and press [OK].

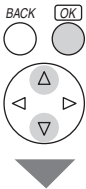

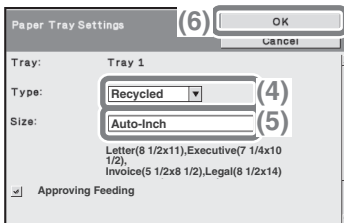
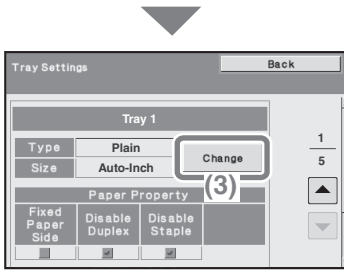

## Configure the tray settings. (Continued)

### (3) Select the [Change] key in "Tray 1".

Select with  $\downarrow$   $\uparrow$   $\leftarrow$   $\rightarrow$  and press [OK].

### (4) Select [Recycled] from the "Type" select box.

Select with  $\downarrow$   $\uparrow$  and press [OK].

### (5) Make Sure that [Auto-Inch] is selected in the "Size" select box.

Select with  $\downarrow$   $\uparrow$  and press [OK].

For more information, see "Paper Tray Settings" in "Chapter 3 - SYSTEM SETTINGS" in the Operation Guide.

### (6) Select the [OK] key.

Select with  $\downarrow$   $\uparrow$  and press [OK].

The above steps change the paper settings for tray 1 to 5-1/2" x 8-1/2" recycled paper.

## Loading paper in bypass tray

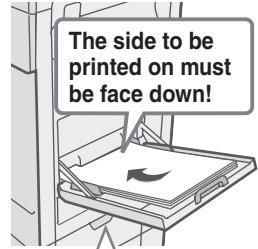
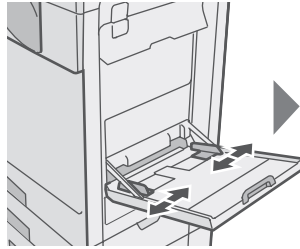
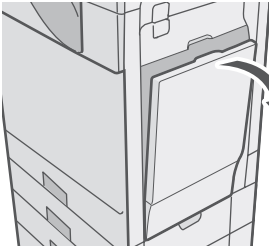

Load the paper in the horizontal orientation.

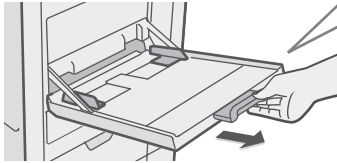

When loading 8-1/2" x 11" size paper, pull out the tray extension. The maximum number of sheets that can be loaded in the bypass tray is approximately 100 for plain paper and approximately 20 for envelopes.

### Example: Loading an envelope

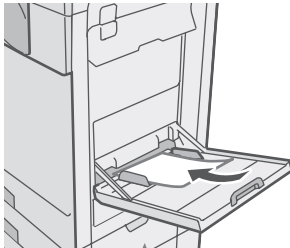

Place paper that is 7-1/4" x 10-1/2" (A5) or smaller in the horizontal orientation.

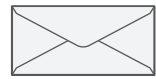

Only the address side of envelopes can be printed on. Place envelopes with the address side face down.

Do not place heavy objects on the bypass tray or press down on the tray. The bypass tray may be damaged, the machine may topple, and injury may result. Special types of paper that cannot be loaded in other trays can be loaded in the bypass tray.

For detailed information on the bypass tray, see "LOADING PAPER IN THE BYPASS TRAY" in "Chapter 1- BEFORE USING THE MACHINE" in the Operation Guide.



# PRINTING

This section explains the basic procedure for printing using the printer driver of the machine. The settings that can be selected in the printer driver are also introduced.

The explanations of screens and procedures are primarily for Windows Vista® in Windows® environments, and Mac OS X v10.4 in Macintosh environments. The window varies depending on the operating system version, the printer driver version, and the application.

▶ <b>PRINTING</b> .....	<b>24</b>
▶ <b>CANCELING PRINTING (AT THE MACHINE)</b> .....	<b>30</b>
▶ <b>SELECTING PRINT SETTINGS</b> .....	<b>32</b>
▶ <b>CONVENIENT PRINTER FUNCTIONS</b> .....	<b>34</b>

# PRINTING

This section explains the basic procedures for printing.

## Windows

The following example explains how to print a letter size document from WordPad, which is a standard accessory program in Windows.

To install the printer driver and configure settings in a Windows environment, see "2 - SETUP IN A WINDOWS ENVIRONMENT" in the Software Setup Guide.

For information on the available printer drivers and the requirements for their use, see "PRINTER FUNCTION OF THE MACHINE" in "Chapter 2 - PRINTING" in the Operation Guide.

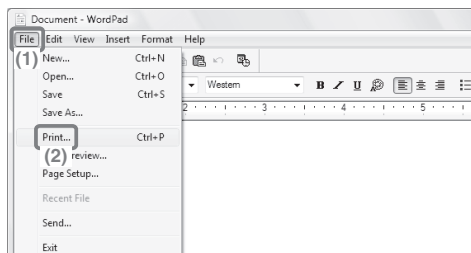

### 1 Select the print command in the application.

#### (1) Open the [File] menu.

In Windows 7, click the  button.

#### (2) Select [Print].

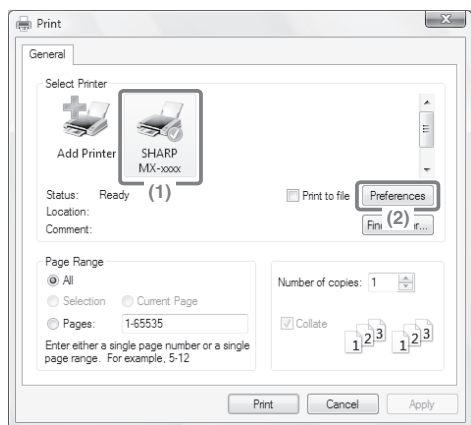

### 2 Open the printer driver properties window.

#### (1) Select the printer driver of the machine.

#### (2) Click the [Preferences] button.

In Windows 2000, the [Preferences] button does not appear. Click the tabs in the "Print" dialog box to adjust the settings on the tabs.

In Windows 98/Me/NT 4.0, click the [Properties] button.

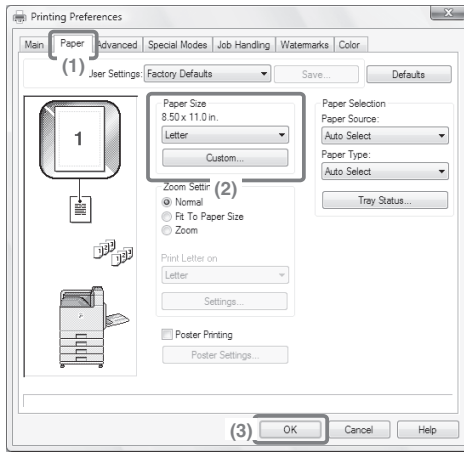

- 3 Select print settings.**
  - (1) Click the [Paper] tab.
  - (2) Select [Letter].
  - (3) Click the [OK] button.

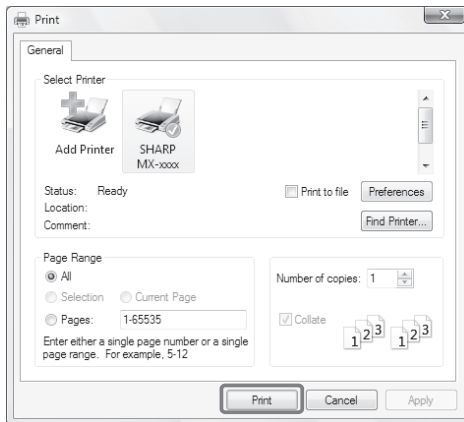

- 4 Click the [Print] button.**

Printing begins.  
In Windows 98/Me/NT 4.0, click the [OK] button.

### When removing printed output...

Remove the output horizontally so that it does not get caught on the actuator for output tray full detection.

# Using printer driver help

When selecting settings in the printer driver properties window, you can display Help to view explanations of the settings. (Only in Windows)

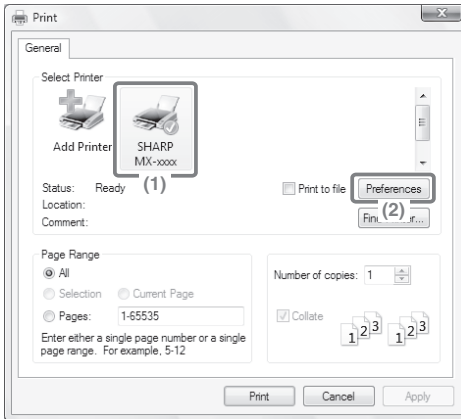

## 1 Open the printer driver properties window.

(1) Select the printer driver of the machine.

(2) Click the [Preferences] button.

In Windows 2000, the [Preferences] button does not appear. Click the tabs in the "Print" dialog box to adjust the settings on the tabs.

In Windows 98/Me/NT 4.0, click the [Properties] button.

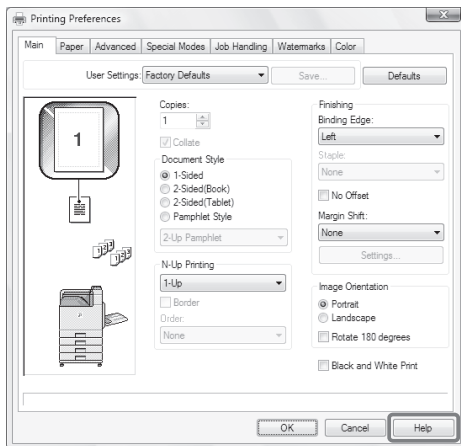

## 2 Click the [Help] button.

The Help window will open to let you view explanations of the settings on the tab.

To view Help for settings in a dialog box, click the green text at the top of the Help window.

**To view Help for a specific setting**

Click the setting that you wish to learn about and press the [F1] key. Help for that setting will appear.

\* To view Help for a particular setting in Windows 98/Me/NT 4.0/2000/XP/Server 2003, click the  button in the upper right-hand corner of the printer driver window and then click the setting.

**When the information icon () appears**

The icon can be clicked to show prohibited combinations of functions and other information.

# Macintosh

The following example explains how to print a letter size document from "TextEdit" ("SimpleText" in Mac OS 9), which is a standard accessory program on Macintosh computers.

In a Macintosh environment, the PS3 expansion kit must be installed to use the machine as a network printer.

To install the printer driver and configure settings in a Macintosh environment, see "3 - SETUP IN A MACINTOSH ENVIRONMENT" in the Software Setup Guide.

## Setting the paper size

Select paper settings in the printer driver before selecting the print command.

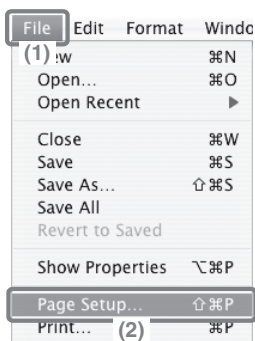

### 1 Open the page setup window in TextEdit.

(1) Open the [File] menu.

(2) Select [Page Setup].

In Mac OS 9, select [Print] from the [File] menu of SimpleText.

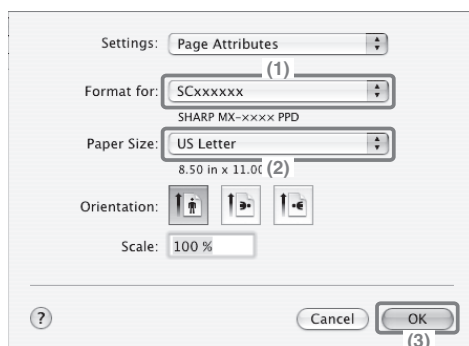

### 2 Select paper settings.

(1) Make sure the correct printer is selected.

The machine name that appears in the "Format for" menu is normally [SCxxxxxx]. In Mac OS X v10.6, it is normally [RDVxxxxxx]. ("xxxxxx" is a sequence of characters that varies depending on your machine model.)

(2) Select [US Letter].

(3) Click the [OK] button.

# Printing a file

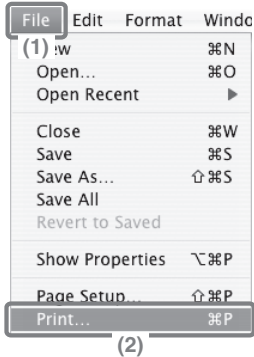

## 1 Execute printing from TextEdit.

(1) Open the [File] menu.

(2) Select [Print].

In Mac OS 9, select [Print] from the [File] menu of SimpleText.

## 2 Select print settings and click the [Print] button.

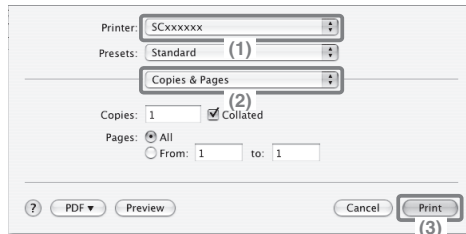



### (1) Make sure the correct printer is selected.

The machine name that appears in the "Printer" menu is normally [SCxxxxxx]. In Mac OS X v10.6, it is normally [RDVxxxxxx]. ("xxxxxx" is a sequence of characters that varies depending on your machine model.)

### (2) Select print settings.

Click  next to [Copies & Pages] and select each setting that you wish to configure from the pull-down menu. The screen for the selected setting will appear.

If the settings do not appear in Mac OS X v10.5 to 10.5.8 and v10.6, click  next to the printer name.

In Mac OS 9, click  next to [General] and select a setting from the pull-down menu. The screen for the selected setting will appear.

### (3) Click the [Print] button.

Printing begins.

## When removing printed output...

Remove the output horizontally so that it does not get caught on the actuator for output tray full detection.

# CANCELING PRINTING (AT THE MACHINE)

You can cancel a job if you cancel before printing actually begins.



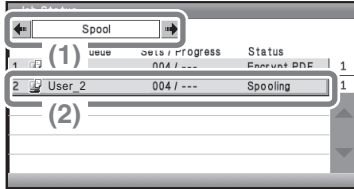

JOB STATUS

**1 Press the [JOB STATUS] key.**





**2 Select settings.**

**(1) Change the job status mode to [Spool] or [Job Queue].**



Select either of the   keys with the   keys and press the [OK] key. The mode changes each time the [OK] key is pressed.

**(2) Select the key of the job that you wish to cancel.**

Select with   and press [OK].



**(3) Select the [Stop/Delete] key.**

Select with   and press [OK].



**Configure the tray settings. (Continued)**

**(4) Select the [Yes] key.**

Select with ⏪ ⏩ and press [OK].

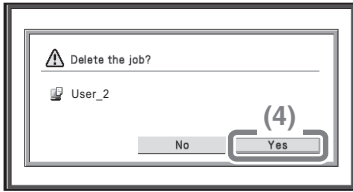

# SELECTING PRINT SETTINGS

To use the print function of the machine, the settings in the printer driver properties window must be configured. See "PRINTING" (page 24) for the procedure for opening the printer driver properties window and the basic procedure for printing.

## Windows

The procedure for selecting settings in the printer driver is explained below using "Fitting the print image to the paper (Fit To Paper Size)" as an example.

The Fit To Paper Size function is used to automatically enlarge or reduce the print image to fit the selected paper size. In this example, an invoice-size image will be printed on letter-size paper.

The procedures for configuring printer driver settings vary by setting. **For more information on each setting, see "FREQUENTLY USED FUNCTIONS" and "CONVENIENT PRINTING FUNCTIONS" in "Chapter 2 - PRINTING" in the Operation Guide.**

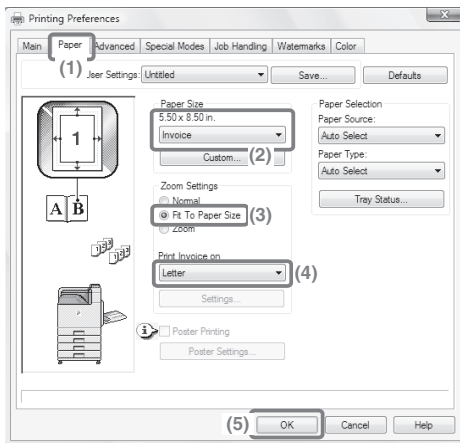

### Select print settings.

(1) Click the [Paper] tab.

(2) Select [Invoice].

Select the size of the print image.

(3) Select [Fit To Paper Size].

(4) Select [Letter].

Select the size of paper that you want to print on.

(5) Click the [OK] button.

This completes the settings. Start printing.

# Macintosh

The procedure for selecting printer driver settings is explained below using "Printing multiple images on one page (N-Up Printing)" as an example. This function reduces the size of each page to let you print multiple pages on one sheet of paper. The example of printing two pages on one sheet of paper with borderlines is explained.

The procedures for configuring printer driver settings vary by setting. **For more information on each setting, see "FREQUENTLY USED FUNCTIONS" and "CONVENIENT PRINTING FUNCTIONS" in "Chapter 2 - PRINTING" in the Operation Guide.**

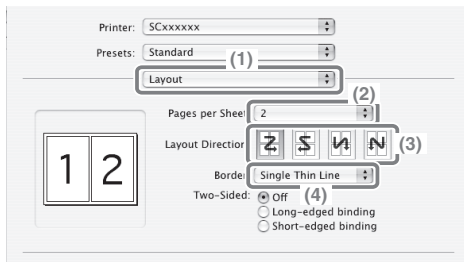

**Select print settings.**

**(1) Select [Layout].**

**(2) Select [2].**

**(3) Select the order of the pages.**

**(4) Select the desired type of borderline.**

# CONVENIENT PRINTER FUNCTIONS

## Printing on both sides of the paper (2-sided printing)

Use this function to print on both sides of the paper. You can use 2-sided printing to reduce the number of printed sheets when you are printing a large number of pages or when you wish to conserve paper.

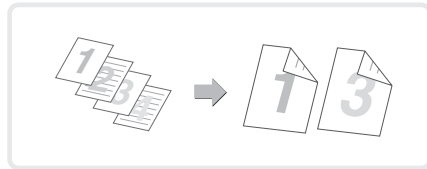

## Fitting the print image to the paper (Fit To Paper Size)

Use this function to enlarge or reduce the print image to fit the paper size. This is convenient for such purposes as enlarging an invoice or A5 size document to letter or A4 size paper to make it easier to view, and to print when the same size of paper as the print image is not loaded in the machine.

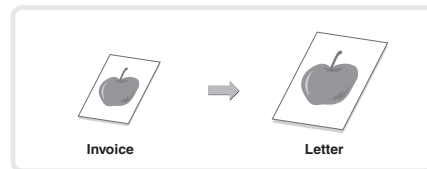

## Printing multiple images on one page (N-Up Printing)

Use this function to print multiple pages on a single sheet of paper by reducing the size of the print images. This is convenient when you wish to show an overall view of multiple pages or conserve paper.

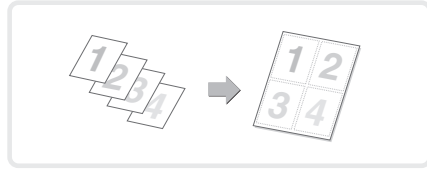

## Stapling printed pages (Staple)

Use this function to staple printed output. (When a finisher is installed.)

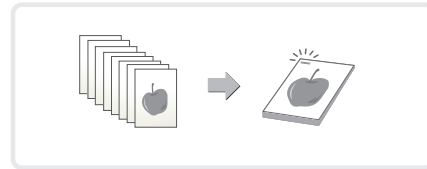

## Printing a color image in grayscale (Black and White Print)

Use this function to print color images in grayscale. This lets you save color toner when color printing is not necessary, such as when you only need to check the contents of a document.

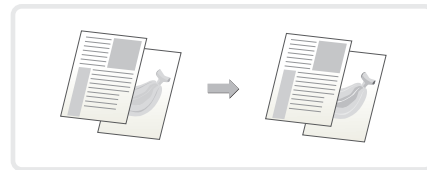

# The machine also has these functions

For information on each of these functions, see "CONVENIENT PRINTING FUNCTIONS" and "RETENTION (PRINT HOLD) FUNCTION" in "Chapter 2 - PRINTING" in the Operation Guide.

## **Convenient functions for creating pamphlets and posters**

- Creating a pamphlet (Pamphlet)
- Increasing margin (Margin Shift)
- Creating a large poster (Poster Printing)

## **Functions to adjust the size and orientation of the image**

- Rotating the image 180 degrees (Rotate 180 degrees)
- Enlarging/reducing the print image (Zoom / XY-Zoom)
- Adjusting line widths when printing (Line Width Settings)
- Reversing the image (Mirror Image)

## **Color mode adjustment function**

- Adjusting the brightness and contrast of the image (Color Adjustment)
- Printing faint text or lines in black (Text To Black/Vector To Black)
- Selecting color settings to match the image (Advanced Color)

## **Functions to combine text and images**

- Adding a watermark to printed pages (Watermark)
- Printing an image over the print data (Image Stamp)
- Creating overlays for print data (Overlays)

## **Print functions for special purposes**

- Printing specified pages on different paper (Different Paper)
- Adding inserts when printing on transparency film (Transparency Inserts)
- Printing a carbon copy (Carbon Copy)
- Printing so that a specific page is the front page when using two-sided printing (Chapter Inserts)

## **Retention (print hold) function**

- Saving print files (Retention)

# System settings

The system settings let you adjust the operation of the machine to suit the needs of your workplace. This section briefly introduces several of the system settings. For detailed explanations of the system settings, see "Chapter 3 - SYSTEM SETTINGS" in the Operation Guide.

► <b>SYSTEM SETTINGS</b> .....	<b>38</b>
--------------------------------	-----------

# SYSTEM SETTINGS

Various settings related to the machine such as the date and time setting and paper tray settings can be configured in the system settings screen. The procedure for opening the system settings screen and the items in the screen are explained below.

For detailed explanations of the system settings, see "Chapter 3 - SYSTEM SETTINGS" in the Operation Guide.

## Displaying the system settings screen

The system settings can be configured on the machine or in the Web page. To configure the settings on the machine, display the system settings screen as shown below.

To configure the settings in the Web page, see "Opening the Web pages" (page 3) to open the Web page.

SYSTEM  
SETTINGS 

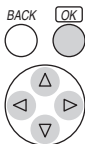
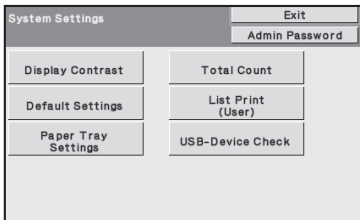

**Press the [SYSTEM  
SETTINGS] key.**

The system settings screen will appear.

The keys that appear will vary depending on what peripheral devices are installed.



# What you can do in the system settings

Settings	Description
Display Contrast (Operation panel only)	The display contrast can be adjusted.
Total Count	This displays the total number of pages printed .
Default Settings	This lets you set the clock and change the software keyboard used for text entry.
List Print (User)	This lets you print lists showing the machine status and settings.
Paper Tray Settings	This is used to set the type and size of paper used in each tray, and to store new paper types.
Printer Condition Settings (Web page only)	This is used to configure settings for printing without using the printer driver and settings for the printer function.
USB-Device Check	This is used to check the connection status of a USB device.

## System settings (administrator)

The system settings (administrator)\* are system settings that can only be configured by the administrator of the machine. To configure these settings, the administrator password must be entered.

However, when user authentication is enabled, users who log in with certain user rights may be able to configure these settings without entering the administrator password. Check with your administrator.

\* Although the manuals for the machine indicate system settings that require administrator rights as "system settings (administrator)", this is only for convenience in explaining the settings. The word "administrator" does not appear in the display or elsewhere on the machine.

For the items of the system settings (administrator), see "Chapter 3 - SYSTEM SETTINGS" in the Operation Guide.



# Troubleshooting

This sections contains answers to frequently asked questions and explains how to remove paper misfeeds.

- ▶ **FREQUENTLY ASKED QUESTIONS** ..... 42
- ▶ **REMOVING MISFEEDS** ..... 46

# FREQUENTLY ASKED QUESTIONS

## Printing on envelopes

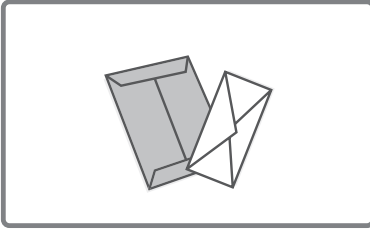

The procedure for printing on an envelope is explained below. Only the name and address side of an envelope can be printed on.

It is recommended that you do a test print to check the print result before using an envelope.

### 1 Place paper in the bypass tray.

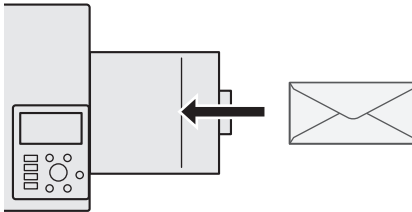

Print on the name and address side

### 2 Tray Settings.

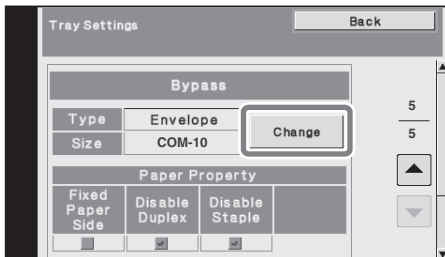

Type : Envelope  
Size : Select the envelope size

### 3 Select settings in the printer driver.

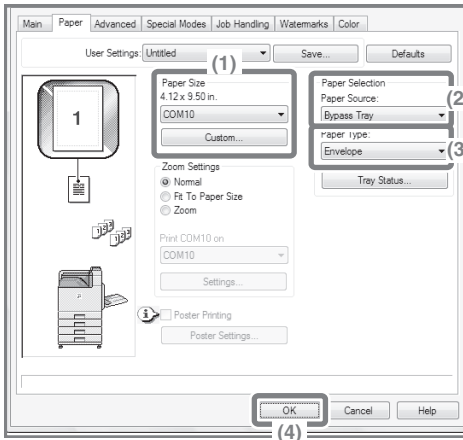

(1) Select the size of the envelope in "Paper Size".

(2) Select "Bypass Tray" from "Paper Source" in "Paper Selection".

(3) Select [Envelope] in "Paper Type".

If needed, select the "Rotate 180 degrees" checkbox () in "Image Orientation" on the [Main] tab.

(4) Click the [OK] button.

# Changing the paper size used for a job

When the size of paper is not loaded in any of the machine's paper trays, follow the steps below to change the paper size.

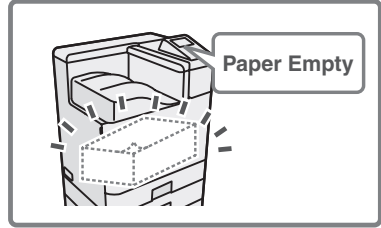

## 1 Check details on the job.

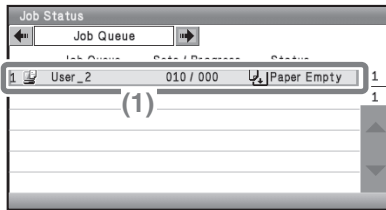

Press the [JOB STATUS] key on the operation panel to display the job status screen.

(1) Select the job whose status is [Paper Empty].

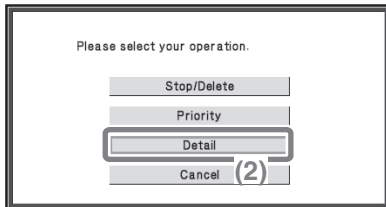



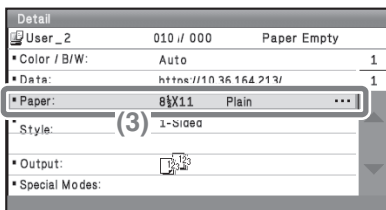

(2) Select the [Detail] key.

To delete the job, you can select the [Stop/Delete] key.



(3) Check the paper size specified for the job in the detail screen, and select the [Paper Select] key.

## 2 Change the paper size used for the job.

Detail		
User_2	010 / 000	Paper Empty
Paper Select		
 1.8x11	Plain	
 2.5x8.5	Plain	
 3.8x14	Plain	
 4.8x11	Plain	
 8x11	Plain	

Select the paper size on which you wish to print the job from the set paper sizes.

To avoid cutting off part of the image, select a paper size that is larger than the paper size specified for the job.

# REMOVING MISFEEDS

When a paper misfeed occurs, the message "A misfeed has occurred." will appear in the display and printing will stop. In this event, select the [Information] key in the display. When the key is selected, instructions for removing the misfeed will appear. Follow the instructions. When the misfeed is cleared, the message will automatically clear.

The blinking  mark in the image at left indicates the approximate position of the misfeed.

Misfeed location

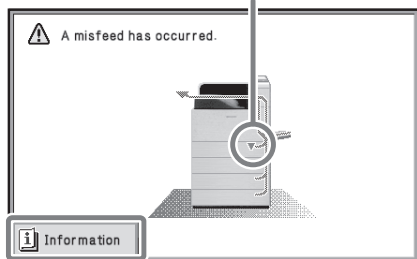

Select the [Information] key to display the following screen.

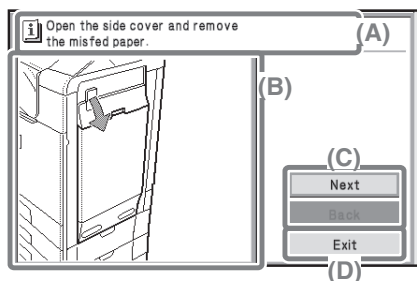

**(A)**Instructions for removing the misfeed appear here.

**(B)**Animation showing what to do.

**(C)**Display the previous screen or the next screen.

**(D)**This closes the information screen.

The information screen cannot be closed until the misfeed is removed.

- While the message appears, printing cannot be resumed.
- If the message does not clear even after the misfeed has been removed, the causes below are possible. Check once again.
  - The misfeed was not correctly removed.
  - A torn piece of paper remains in the machine.
  - A cover or unit that was opened or moved to remove the misfeed was not returned to its original position.

For detailed procedures for removing misfeeds, see "REMOVING MISFEEDS" in "Chapter 4 - TROUBLESHOOTING" in the Operation Guide.







## Please note

---

- For information on your operating system, please refer to your operating system manual or the online Help function.
- The explanations of screens and procedures in a Windows environment are primarily for Windows Vista®. The screens may vary depending on the version of the operating system or the software application.
- The explanations of screens and procedures in a Macintosh environment are based on Mac OS X v10.4 in the case of Mac OS X. The screens may vary depending on the version of the operating system or the software application.
- Wherever "MX-xxxx" appears in this manual, please substitute your model name for "xxxx".
- Considerable care has been taken in preparing this manual. If you have any comments or concerns about the manual, please contact your dealer or nearest SHARP Service Department.
- This product has undergone strict quality control and inspection procedures. In the unlikely event that a defect or other problem is discovered, please contact your dealer or nearest SHARP Service Department.
- Aside from instances provided for by law, SHARP is not responsible for failures occurring during the use of the product or its options, or failures due to incorrect operation of the product and its options, or other failures, or for any damage that occurs due to use of the product.

## Warning

---

- Reproduction, adaptation or translation of the contents of the manual without prior written permission is prohibited, except as allowed under copyright laws.
- All information in this manual is subject to change without notice.

## Illustrations and the operation panel shown in this manual

---

The peripheral devices are generally optional, however, some models include certain peripheral devices as standard equipment.

The explanations in this manual assume that 500-sheet paper feed units (total of four trays) are installed on the machine.

For some functions and procedures, the explanations assume that devices other than the above are installed.

<p>The display screens, messages, and key names shown in the manual may differ from those on the actual machine due to product improvements and modifications.</p>
--

# SHARP®

## SHARP ELECTRONICS CORPORATION

1 Sharp Plaza, Mahwah, New Jersey 07495-1163.

[www.sharppusa.com](http://www.sharppusa.com)

## SHARP ELECTRONICS OF CANADA LTD.

335 Britannia Road East, Mississauga, Ontario, L4Z 1W9

SHARP CORPORATION

